







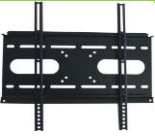

## HOWLO LCD BRACKET PRICE LIST

For detailed product information please go to [www.howlo.co.za](http://www.howlo.co.za)

Last Updated: February 2016

Product Number	Picture (click on picture for weblink)	Product Description	New List Price ex vat
<b>FLAT MOUNTS</b>			
FC888SB		Mini hook wall mount connector .Up to 30 Kg.Vesa mounts:75 x75mm,100 x100mm	R 147.00
AL1201B		Fixed design.Suitable for 32"-60".Support up to 80Kgs.32"-55" universal, lockable, Max VESA 700X500.TV mounted 24mm off the wall.Wall plate 820 x235mm.Arm length 530mm.With security locking system.	R 472.00
AL1201S		Fixed design.Suitable for 23"-37".Support up to 56Kgs. VESA 500 X 300 mm.TV is mounted 25mm off the wall.Arm length 510mm.With security locking system	R 452.00
HL1201S		Fixed design. Suitable for 23" - 37" screens. Support up to 56kgs. VESA 400 X 400mm. TV is mounted 25mm from the wall. Arm Length 410mm. With a security locking system.	R 495.00
<b>SWIVEL &amp; TILT MOUNTS</b>			
A800		Ball joint swivel and tilt mount . 100X100, 75X75 lcd bracket. Loading capacity15Kg .	R 524.00
FC888S		3 Direction Mini Wall mount swivel and tilt (15Kg load).Swivel left &right 90 degrees.LCD monitor swivel 180 degrees.Vesa 75 x75,100 x100 mm.	R 476.00
A630		Universal wide swivel and tilt mount with full 360 rotation.Minimum vesa:200 x350mm Maximum vesa:400 x660mm.Accomodate 32"-52"	R 2,150.00

**SWING ARMS**

FC888WP		Wall Mount with 180 degree left and right. Swivel connecting head with 270 degree left and right movement and 180 degree up and down movement. VESA 75*75mm, 100*100mm. Intergrated cable management	R1,507.00
A871		Articulated wall mount. Up to 32" .Max wieght 32kgs. Vesa 75 x75, 100x 100 200X200mm .Horizontal adjustable 20 degrees. Tilt 5-15 degrees. Horizontal moving distance +/-465mm	R 1,324.00
A811B (Black)		Articulated arm for LCD up to 26" .Loading capacity 15 kg Vesa 100X100, 75X75 (15Kg). Horizontal moving distance +/-535mm.	R 1,073.00
A771		Universal wide large format articulated mount up to 50Kg. Max vesa 749 x620mm.	R 4,433.00

**CEILING MOUNTS**

A160		Supports 32"-52"and lcd & plasma screens up to 20 degree tilt mount. Max vesa mounts 800x520 mm. Maximum height 2100 mm.	R 2,765.00
A160B		Ceiling mount Supports 32"-52"and lcd & plasma screens up to 20 degree tilt mount .Maximum height 2100 mm. 100 to 200X200 VESA mount up to 135 Kg	R 2,765.00
FC888SL		Ceiling Mount 15"-26" .Up to 15kgs. VESA 75x75 and 100 x100 mm	R 1,129.00
AL1001H		Universal projector mount in satin black. Load weight 30kgs. 360° swivel adjustable tilt. Intergrated cable management. Height adjustable to 420mm. * Optional extensions are available at an additional charge and may be subject to a lead time. *	R 683.00

**DESK MOUNTS**

A810B		<p>Desk mount c-clamp articulated mount for LCD.Up to 26" LCD monitor.Loading capacity 15kg.Vesa 75 x75 ,100 x100 mm.Horizontal distance+/- 535mm,vertical moving distance 300-435mm.Desk thickness:10-105mm</p>	R 1,625.00
A820M81		<p>Twin arm LCD screen mount on swing arm. C-Clamp.Twin arm LCD screen mount on articulated arm. C-Clamp.Up to 26".Loading capacity 15kg.Vesa 75 x75mm,100 x100mm.Horizontal distance+/-540mm,vertical moving distance 300-435mm.Desk thickness:10-105mm</p>	R 2,792.00
A820M811		<p>Twin arm LCD screen mount on articulated arm. C-Clamp.Up to 26".Loading capacity 15kg.Vesa 75 x75mm,100 x100mm.Horizontal distance+/-540mm,vertical moving distance 300-435mm.Desk thickness:10-105mm</p>	R 2,812.00
A840M81		<p>Four screen desk mount swing arm, c-clamp.Twin arm LCD screen mount on swing arm. C-Clamp.Up to 26".Loading capacity 15kg.Vesa 75 x75mm,100 x100mm.Horizontal distance+/- 540mm,vertical moving distance 300-435mm.Desk thickness:10-105mm</p>	R 4,322.00
A840M811		<p>Four screen desk mount with articulated arm, c-clamp.Twin arm LCD screen mount on articulated arm. C-Clamp.Up to 26".Loading capacity 15kg.Vesa 75 x75mm,100 x100mm.Horizontal distance+/-540mm,vertical moving distance 300-435mm.Desk thickness:10-105mm</p>	R 4,545.00
FC8888HP		<p>Vertical and horizontal full motion grommet desk mount bracket .Up to 7Kg Load.Vesa 75 x75,100 x100</p>	R 1,550.00

FC8888P		Vertical and horizontal full motion C-Clamp desk mount bracket .Up to 7Kg Load.Vesa 75 x75,100 x100	R 1,550.00
A813		Desk mount grommet-clamp articulated mount for LCD.Up to 27" Lcd monitor.Up to 15kg loading capacity.Vesa 100 x100,75 x75mm .Horizontal distance+/-535mm,vertical moving distance 300-435mm.Desk thickness:10-75mm	R 1,644.00
A862		Any 15"-20"LCD Monitor with VESA standards (75X75mm/ 100X100mm.Swivel left &right 15degrees,Pivot up &down 20 degrees.Monitor swivel 36 degrees.Vertical distance 300-425mm	R 3,297.00
A822		Max Load: 10kgs / each arm. Meet VESA standard: 75*75/100*100mm. Monitor Horizontal adjustable:±30°; Monitor up & down tilting ±30°. TV Mount left & right sswivel : 360°	R 3,036.00
A816		Pole mount for LCD monitor. Up to 27" Lcd monitor.Vesa100X100, 75X75 articulated arm for LCD (15Kg).Swive 20 degrees,LCD monitor swivel 180 degrees.Horizontal distance+/- 575mm,vertical moving distance 70-660mm	R 1,624.00

OFFICE ACCESSORIES

A310		Wall mount work stand configured with A300 series.MS-short LCD holder,ML-cable management system.	R 3,130.00
A320 G/C		Grommet or C-clamp desk stand ,Up to 60 kgs; Up to 32" with conversion plate; can be configured to hold up to six 22" screen. The Unit consists of a pole, grommet clamp or c-clamp and a short arm lcd holder only. Additional accessories sold seperately	R 3,250.00
A300M81		Swing arm	R 1,416.00
A300M811		Articulated swing arm	R 1,503.00
A300MC		Cpu Holder	R 1,103.00
A300MK		Key board arm	R 2,280.00
A300MN		Speaker tray	R 824.00
A300MRA		1,5 M pole for 300 series	R 2,911.00
A300MS		Short LCD swivel connector	R 871.00
A300MT		Printer tray	R 876.00
WWS001A		Wall Mountable keyboard workstation.	R 1,133.00
FC2050 / FC200		Swivel mouse arm.Loading weight 12kgs.360 degrees swivel arm holder.	R 1,016.00
FC2150		Ergonomic swivel and tilt keyboard tray.Platform tilt adjustment 15-20 degrees.Base swivel 360 degrees.Max height adjustment 160mm,moving up:60mm,down:100mm	R 1,441.00
A910		Two way articulated Hospital arm.Up to 8Kg	R 12,408.00
FC666		Swivel CPU tray for under desk mount.360 degree two way rotation.	R 740.00

**MOBILE STANDS**

A300		<p>Mobile work stand .Height 1.5m configured with:MT-printer tray,MN-speaker tray,MK-ergonomic keyboard tray,ML-cable management system,MC-Cpu Holder,MS-short Lcd Holder VESA 75*75mm &amp; 100*100.</p>	R 13,100.00
A300M81		Swing arm	R 1,416.00
A300M811		Articulated swing arm	R 1,503.00
A300MC		Cpu Holder	R 1,103.00
A300MK		Key board arm	R 2,280.00
A300MN		Speaker tray	R 824.00
A300MRA		1,5 M pole for 300 series	R 2,911.00
A300MS		Short LCD swivel connector	R 871.00
A300MT		Printer tray	R 876.00
A330B		<p>LCD Stand with universal lcd mount. 100Kg load capacity. Glass shelves. Max VESA 700mm * 500mm</p>	R 11,169.00
X Stand H		<p>Mobile LCD TV Stand for 32"-52:" Up to 30 KG.Max vesa 400 x700 mm.</p>	R 4,533.00
Brand stand		<p>Brand stand for 32"-52" LCD TV .Up to 30kg .Max vesa 400 x700 mm.</p>	R 6,515.00
Elift X Stand		<p>Linak Control Box(SN/0077432),with DL4 Column(SN/6134000),Desk Panel,handset for desk,8Pole RJ45 Cale,Motor Cable,Powercord and remote.</p>	R 18,689.00
Linak TV Lift Wall Cupboard Mount		<p>Vall or Cupboard Mount TV Lift. Holds up to 60 kgs</p>	R 18,325.00

## PROFESSIONAL RANGE

### FLAT MOUNTS

AL1201B		Fixed design. Suitable for 32"-60". Support up to 80Kgs. 32"-55" universal, lockable, Max VESA 700X500. TV mounted 24mm off the wall. Wall plate 820 x235mm. Arm length 530mm. With security locking system.	R 472.00
---------	---	--	----------

AL1201S		Fixed design. Suitable for 23"-37". Support up to 56Kgs. VESA 500 X 300 mm. TV is mounted 25mm off the wall. Arm length 510mm. With security locking system	R 452.00
---------	---	---	----------

HL1201S		Fixed design. Suitable for 23" - 37" screens. Support up to 56kgs. VESA 400 X 400mm. TV is mounted 25mm from the wall. Arm Length 410mm. With a security locking system.	R 495.00
---------	---	--	----------

AL2504CL1		Flat wall mount. Suitable for 30" - 64". Supports up to 64kgs. VESA 600 X 400mm. Distance to the wall 43mm. Lockable.	R 419.00
-----------	---	---	----------

AL2504CM1		Flat wall mount. Suitable for 23" - 42". Supports up to 45kgs. Distance to the wall 43mm. Lockable.	R 295.00
-----------	--	---	----------

AL2503S		Fixed design wall mount. Suitable for 14"-32" Support up to 35Kgs. VESA 200 X 200 mm	R 263.00
---------	---	--	----------

### TILT MOUNTS

AL2401B		Tilting wall mount. Suitable for 23"-60" Support up to 75Kgs Tilt: -15° to 15°. VESA 600 X 400 mm .TV is mounted 50mm off the wall	R 442.00
---------	---	---	----------

AL2402S		Tilting wall mount. Suitable for 14"-32". Support up to 45Kgs. Tilt: -15° to 15° VESA 200 X 200 mm TV is mounted 70mm off the wall.	R 263.00
---------	---	---	----------



AL2302B		Fixed design wall mount. Suitable for 23"-60" Support up to 75Kgs. Tilt: -15° to 15°. VESA 700 X 500 mm. TV is mounted 80mm off the wall	R 545.00
---------	---	--	----------

AL2302M		Fixed design wall mount. Suitable for 23"-42". Support up to 50Kgs Tilt: -15° to 15°. VESA 400 X 300 mm TV is mounted 80mm off the wall	R 495.00
---------	---	---	----------

**SWIVEL & TILT MOUNTS**

AL3601A		Full motion wall mount. Suitable for 13"-22". Support up to 15Kgs. Level revolve 360°. Swivel 180°. VESA 75 X 75 mm, 100 X 100mm	R 123.00
AL3601B		Full motion wall mount. Suitable for 13" - 22" screens. Support up to 15kgs. Tilt 90 degrees, Rotate 360 degrees. Swivel 180 degrees. VESA 75 x 75mm, 100 x 100mm	R 171.00
LCD100		Screen size: 13"-27". Max weight: 20Kg(44lbs) Pan & Tilt: 60° & -15° to 15° Mount pattern: VESA 75/100. Product size: 192 x 120 x 100mm. Aluminum alloy	R 340.00

**DESK MOUNTS**

DM101		Single screen desk mount. Screen size: 13"-24" Max weight: 15Kg Tilt: -15° to 15°. Mount pattern: VESA 75/100 Swivel : 360°	R 912.00
DM102		Dual Screen Mount. Screen size: 13"-24". Max weight: 15Kg of each screens. Tilt: -15° to 15°. Mount pattern: VESA 75/100. Swivel : 360°	R 1,439.00
DM104		Four Screen mount. Screen size: 13"-24". Max weight: 15Kg of each screens. Tilt: -15° to 15°. Mount pattern: VESA 75/100. Swivel : 360°	R 2,537.00



**CEILING MOUNTS**

CL08		Ceiling mount. Screen size - 13" - 27" screens, VESA 75*75mm and 100*100mm and supports up to 15kgs. Swivel and tilt head. Height adjustable from 500mm - 950mm. * Optional extensions are available at an additional charge and may be subject to a lead time. *	R 471.00
------	---	---	----------

AL5001M		Ceiling bracket Suitable for 32"-42" Support up to 75Kgs Tilt: -15°to 15° Swivel 360° Extension:600mm to 950mm TV plate 530mm wide, 210mm high Arm length 423mm. * Optional extensions are available at an additional charge and may be subject to a lead time. *	R 724.00
---------	---	--	----------

AL5001B		Ceiling bracket Suitable for 37"-60" Support up to 75Kgs Tilt: -15°to 15° Swivel 360° Extension:600mm to 950mm TV plate 800mm wide, 210mm high Arm length 528mm. * Optional extensions are available at an additional charge and may be subject to a lead time. *	R 807.00
---------	---	--	----------

**SWING ARMS**

LCD102		Screen size: 13"-27".Max weight: 20Kg(44lbs) Pan & Tilt: 180° & -15°to 15°Mount pattern: VESA 75/100.Product size: 270 x 120 x 100-400mm Aluminum alloy.	R 421.00
--------	---	--	----------

LCD105		Screen size: 17"-37".Max weight: 30Kg(66lbs) Pan & Tilt: 180° & -15°to 15°.Mount pattern: VESA 100/200.Product size: 332 x 253 x 100-400mm Aluminum alloy	R 766.00
--------	--	---	----------

AL4106M		Full motion wall mount,Suitable for 32"-60".Support up to 80Kgs.Tilt: -15°to 15°.Extension from 120mm to 665mm.VESA 600 X 400 mm	R 1,362.00
---------	---	--	------------

**ACCESSORIES**

Conversion Plate 100X100, 200X200		Converion Plate.Vesa 75 x75, 100 x100, 200 x200mm	R 105.00
-----------------------------------	---	---	----------

**MISC CUSTOM ITEMS**

Tablet Pole Mount		Mount any tablet, ipad or netbook to a pole. this is a custom unit and requires a detailed brief from the client, with a spec sheet. A manufacturing lead time will apply.	POA
-------------------	---	--	-----

Tablet Stands		Securely enclose any tablet/ipad for piece of mind at reception areas, events, retail stores, customer feedback points, hotels, casinos. Can be freestanding or desk mounted. this is a custom unit and requires a detailed brief from the client, with a spec sheet. A manufacturing lead time will apply.	POA
---------------	---	---	-----

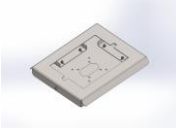
Tablet Enclosures		Securely enclose any tablet/ipad for piece of mind at reception areas, events, retail stores, customer feedback points, hotels, casinos. Can be freestanding or desk mounted. this is a custom unit and requires a detailed brief from the client, with a spec sheet. A manufacturing lead time will apply.	POA
-------------------	---	---	-----



POS - Credit Card Machine Holders

Credit card machine holder is made to your unique specifications and application. It is heavy duty and made from precision cut steel for a long term solution to your point of sale needs. This is a custom unit and requires a detailed brief from the client, with a spec sheet. Manufacturing lead times will apply. First price is to work off a sample unit.

POA



Hard Drive Mounts

Can accommodate various vesa configurations, can be mounted to any bracket, this is a custom unit and requires a detailed brief from the client, with a spec sheet. A manufacturing lead time will apply.

POA

Mini PC Mount

Can accommodate various vesa configurations and can be mounted to any bracket. This is a custom unit and requires a detailed brief from the client, with a spec sheet. Manufacturing lead times will apply. First price is to work off a sample unit.

POA



Fingerprint Reader

Can accommodate various vesa mounting configurations and can be mounted to any bracket. This is a custom unit and requires a detailed brief from the client, with a spec sheet. Manufacturing lead times will apply. First price is to work off a sample unit. Simple installation and assembly.

POA



Mall Stand

Suitable for 55" Screen  
Stand is w871.30mm x h2025.55mm x d189mm  
Base of Stand is 900 x 450  
Suitable for screen up to 30 kgs  
VESA Mount : 600\*400mm

POA



Video Walls

A complete video wall solution  
Mild Steel or Aluminium Extrusions  
Spec sheet of the screen is required  
A manufacturing lead time may apply

POA